

MMI-8xx Series



MMI-850

Installation Instruction

MMI-8xx Series	1
1.0 Environmental Considerations	1
2.0 Mounting Instructions	1
3.0 Power Connections.....	2
4.0 Communications Connections.....	6
5.0 Dip Switch Settings.....	9
6.0 MMI Indicator Lights.....	9
7.0 Other Hardware Considerations	9
8.0 Trouble Shooting.....	10

1.0 Environmental Considerations

See Specifications for environmental constraints.

Location The MMI Series is designed for use in a factory environment. It is designed to operate from 32 to 113 °F (0 to 45 °C) temperatures, as found in most industrial environments. It may not be suitable for use in certain outdoor applications. Please consult the factory for advised usage in outdoor applications.

NEMA Rating The MMI Series front bezel is NEMA 4 rated. When installed properly in a NEMA 4 panel, the NEMA 4 rating of the panel is not compromised. This means that fluids do not enter the panel through the MMI series panel during wash downs.



Do not operate the unit in areas subject to explosion hazards due to flammable gases, vapors or dusts.



The unit should not be installed where fast temperature variations and/or high humidity are present. This causes condensation of water in the device.



Avoid installing units in environments where severe mechanical vibration or shocks are present.
Vibration endurance: 10 to 25 Hz (X,Y,Z direction 2G 30 minutes)

2.0 Mounting Instructions

2.1 LOCATION CONSIDERATIONS

Care should be taken when locating equipment behind the unit to ensure that AC power wiring, PLC output modules, contactors, starters and relays, and any other source of electrical interference are located away from the back of the unit.

Particular note should be taken to the position of variable speed drives and switching power supplies. Their input and load cables should be screened to a central star earth point.

2.2 MAKING A NEMA-4 MOUNTING

Panel Details The unit can be mounted into panels with a depth of 4”(105mm). It is recommended that the unit be mounted on the front panel of a steel enclosure, through an appropriate opening. Allow a clearance of 1”(25mm) around the sides of the unit for mounting hardware. Allow clearance for cable connections to the back of the unit. Unit depth may vary according to cable type used. Typically, plan a depth to accommodate at least 3”(105mm) behind the panel.

Note: Deburr and clean cutout before beginning installation.

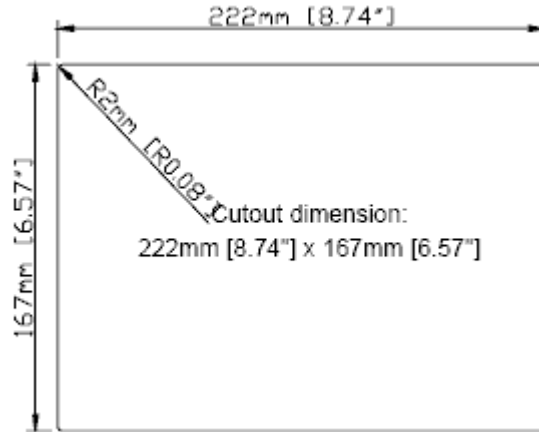

Cutout dimensions

NEMA-4 Mounting Put the unit through the panel cut out. Slide the clamps into the 4 or 6 holes provided around the case. Tighten the clamping screws in an even pattern until the unit is secured in the panel.

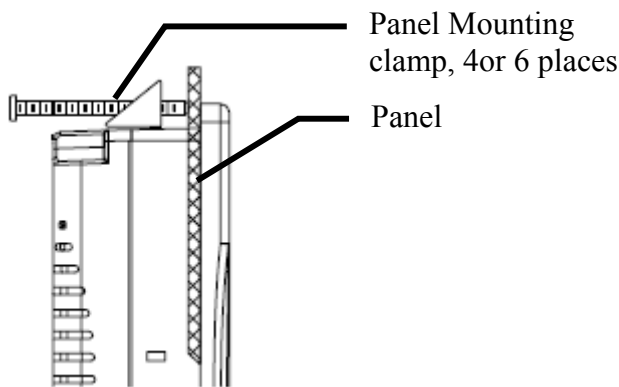

Caution! Do not over tighten mounting clamps!

Note: To seal to NEMA-4 specifications, all supplied mounting clamps must be used and panel must not flex more than 0.010”.

3.0 Power Connections

Make sure that all local and national electrical standards are met when the installing the unit. Contact your local authorities to determine which codes apply.

3.1 POWER REQUIREMENTS



Power

The MMI can be powered by DC power only. The specified voltage range is +22 to 25 Volts DC. This insures compatibility with most controller DC systems.

The power conditioning circuitry inside the unit is accomplished by a switching power supply. The peak starting current can be as high as 700mA.





Fusing Requirements

It is recommended that all input power lines be protected from incorrect wiring or product failure by a **2 Amp** fuse or a breaker.

Note: If the display does not come on within 2 seconds of power up, remove power. An internal fuse prevents damage if the polarity of the DC power is incorrect. Check wiring to insure proper connections and try to power up again.

 **Warning! High Voltage** Connecting high voltages or AC power mains to the DC input makes the unit unusable and may create a hazard to personnel. Such a failure could result in serious personal injury, loss of life and or equipment damage. DC voltage sources should provide proper isolation from main AC power and similar hazards.

 **Supply Voltage Condition** Do not power the MMI and inductive DC loads, or input circuitry to the controller, with the same power supply.
Note: The 24 VDC output from some controllers may not have enough current to power the MMI.

 **Wire Routing** Wire lengths should be minimized.
Wires should be run in pairs with a neutral or common paired with a hot or signal line.

Always use shielded cable to prevent unwanted electrical interference.

If wiring is to be exposed to lightning or surges, use appropriate surge suppression devices.

Keep AC, high energy, and rapidly switching DC wiring separate from signal wires by at least 8 inches. If signal wires must cross AC power, cross at right angles.

Equip ungrounded DC supplies with a resistor and capacitor in parallel to earth ground. This provides a path for static and high frequency dissipation. Typical values to use are 1M Ω and 4700pF.

 **Electrical Environment** The MMI Series has been tested to conform to European CE requirements. The circuitry is designed to resist the effects of electrical noise. This does not guarantee noise immunity in severe cases. Proper wire routing and grounding insures proper operation. The MMI Series is also UL certified.

 **Warning! Emergency Stop** A Hard-wired EMERGENCY STOP should be fitted in any system using an MMI to comply with ICS Safety Recommendations.

 **Grounding Requirements** \perp Chassis ground must be used. DC ground is not directly coupled to Earth ground internally. It is preferable not to ground DC negative return to chassis ground. Poor site earths can introduce noise into a system. If necessary, an earth connection should be made from the power supply return point to the central star earth point.

Ground conductors should be as short and as large in diameter as possible. The conductors must always be large enough to carry the maximum short circuit current of the path being considered. Ground conductors should be connected to a tree from a central star earth ground point. This ensures that no ground conductor carries current from any other branch.

 **CE Requirements** To make an MMI comply with EMC directives, and to reduce susceptibility to electrical interference, a separate #14 AWG ground wire should be taken to the chassis ground terminal of the power connector. This ground connection should be run directly to the central star earth connection point (as recommended in most Installation Instructions).

Use a ferrite core on the power wiring to reduce radiated emissions from the DC power lines. It is recommended to use a 140 Ω @100MHz ferrite core with the DC power lines looped through the core once. Position the ferrite core less than 1" away from the DC power connection points on the back of the MMI.



140 Ω @ 100MHz ferrite

3.2 POWER CONNECTION



Connection

+24 VDC Wiring Diagrams

Use 18 AWG wire to connect positive DC line to the **+24V (DC+)** terminal and the DC ground to the **-DC** terminal. See text above about \perp Chassis Ground.

Terminal Block: To make a connection, strip about 3/8" of insulation off the end of the wire, turn the connector screw counterclockwise until the hold down plate is open wide enough to insert the wire. Insert the stripped portion of the wire under the plate and turn the screw clockwise until it's tight.

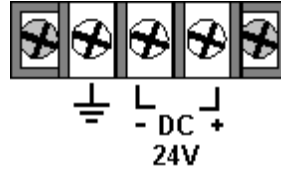

3.3 SAFETY GUIDELINES

This section presents recommended installation practices, and procedures. Since no two applications are identical, these recommendations should be considered as guidelines.

Hardware Considerations



WARNING!

The system designer should be aware that devices in Controller systems could fail and thereby create an unsafe condition. Furthermore, electrical interference in an operator interface, such as an MMI, can lead to equipment start-up, which could result in property damage and/or physical injury to the equipment operator.

If you, or your company, use any programmable control systems that require an operator or attendant, you should be aware that this potential safety hazard exists and take appropriate precautions. Although the specific design steps depend on your particular application, the following precautions generally apply to installation of solid-state programmable control devices. In addition, these precautions conform to the guidelines for installation of Controllers as recommended in the NEMA ICS 3-304 Control Standards.

Programming Considerations

To conform with ICS Safety Recommendations, checks should be placed in the controller to ensure that all writable registers that control critical parts of plant or machinery have limit checks built into the program, with an out-of-limit safe shut down procedure to ensure safety of personnel.

ICS 3-304.81 Safety Recommendations:

Consideration should be given to the use of an emergency stop function, which is independent of the programmable controller.

Where the operator is exposed to the machinery, such as in loading or unloading a machine tool, or where the machine cycles automatically, consideration should be given to the use of an electromechanical override or other redundant means, independent of the programmable controller, for starting and interrupting the cycle.

If provision is required for changing programs while the equipment is in operation, consideration should be given to the use of locks or other means of assuring that such changes can be made only by authorized personnel.

*These recommendations are intended as safeguards against the failure of critical components and the effects of such failures or the inadvertent errors that might be introduced if programs are changed while the equipment is in operation. **

* The ICS 3-304.81 Safety Recommendations are reproduced by permission of the National Electrical Manufacturers Association from NEMA ICS 3-304

CE Requirements

EU directives that apply to the MMI Series

- EMC Directive (89/336/EEC, 92/31/EEC, 93/68/EEC) electromagnetic emissions and immunity
- Machinery Directive (89/392/EEC, 91/368/EEC, 93/44/EEC, 93/ 68/EEC) machine safety

MMI products are CE-marked to indicate compliance with the EMC Directive. Declarations of Conformity that specify the directive(s) and the catalog numbers of the products covered are available from Kessler Ellis Products.

The MMI Series has been designed to operate satisfactorily in electromagnetic noise (immunity) and without emitting high levels of electrical noise into the environment (emission). The units are designed to meet European Community standards when installed per the wiring instructions in this manual.

Compatibility Standards

The MMI has been designed to meet electromagnetic compatibility for industrial environments.

Standard	Description
CISPR (EN 55011) Group 1, Class A	Radiated Emissions levels
EN50081-2	Generic emission standard, industrial environment (Also US FCC Class A)
EN50082-2	Generic immunity standard, industrial environment

General Installation Guide Lines for EU Installations.

- Be aware that wiring leaving the cabinet where the unit is installed may be exposed to interference sources.
- The installation practices in the individual product installation manuals of other components in the system must also be followed.
- Locally applicable grounding safety regulations and machinery directives should be followed for providing a protective ground to earth. The EMC ground must be a low impedance, low inductance path to the machine chassis ground.
- Power supply to the unit must be through an IEC-rated isolation transformer.
- The Power supply to the controller must be controlled to ensure that it does not exceed over voltage category II per EN60204-1 (IEC 240).
- Other requirements of the Machinery Directive involving displays, languages, instructions, Emergency Stop functions, machine operation, protective guards and interlocks are the responsibility of the machine manufacturer.
- Use a ferrite core on the power wiring to reduce radiated emissions from the DC power lines. It is recommended to use a 140Ohm@100MHz ferrite core with the DC power lines looped through the core once. Position the ferrite core less than 1” away from the DC power connection points on the back of the MMI.

General Safety Guide Lines for EU Installations.

Only qualified personnel should be allowed to specify, apply, install, operate, maintain or perform any other function related to MMI products. Qualified persons are defined as follows:

- System application and design engineers who are familiar with the safety concepts of automation equipment.
- Installation, start-up, and service personnel who are trained to install and maintain automation equipment.
- Operating personnel trained to operate automation equipment and trained on the specific safety issues and requirements of the particular equipment.

Make sure that the voltage range for the equipment is correct before switching on the equipment.

Emergency-tripping devices in accordance with EN60204/IEC204 must be effective in all operating modes of the automation equipment. Resetting the emergency off device must not result in any uncontrolled or undefined restart of the equipment.

Automation equipment and its operating elements must be installed so that unintentional operation is prevented.

Make sure that operating sequences, interrupted by a voltage dip or power supply failure, resume proper operation when the power supply is restored. If necessary, the equipment must be forced into the “emergency off” state.

Install the power supply and signal cables so that inductive and capacitive interference voltages do not affect automation functions.

4.0 Communications Connections

The ports as you look at the back of the case, are the ports for connecting to a printer, PLC or some external device (Controller Connectors).

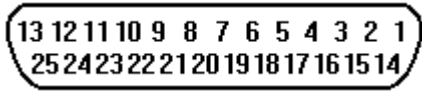

Printer Port
(25p D-Female)

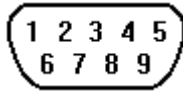

PLC [RS-232] Port
(9 pin D-Female)

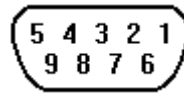

PC [RS-232] &
PLC [RS-485] Port
(9 pin D-Male)

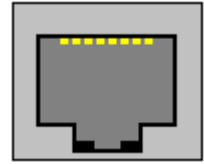

Ethernet Port
(RJ-45 Male)

4.1 CONNECTION TO A PERSONAL COMPUTER

The 9 Pin, Female, D-SUB, **PC [RS-232] & PLC [RS-485]** Port on the back of the unit is the programming port (PC Connector) and RS485/422 communications port for connecting to a controller. The Auxiliary (AUX) RS485 port is also accessed through this connector.

Connection This port can be attached to a Computer via a special DB9 Female to DB9 Female cable provided with the unit. (KEP P/N: MT5_PC)

Port Activation This port is activated automatically by the PC during: On line simulation, Download and Upload activities. The Programmer Port cannot simulate, download or upload to the MMI while it is on line with the controller at the same time. The MMI must be put into “RDS” mode with the EasyManager applet first.

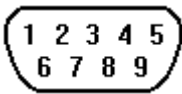

Pin Designations

Pin assignment of the 9 Pin, Male, D-SUB **PC [RS-232] & PLC [RS-485]** Port

Pin #	Symbol	PLC[RS485] 2 Wire	PLC[RS485] 4 Wire	AUX[RS485] 2 Wire	PC[RS232]
1	PLC RxD-	Transmit/ Receive -	RS485 Receive		
2	PLC RxD+	Transmit/ Receive +	RS485 Receive		
3	PLC TxD-		RS485 Transmit		
4	PLC TxD+		RS485 Transmit		
5	GND	Signal Ground	Signal Ground	Signal Ground	Signal Ground
6	AUX Data +			Transmit/ Receive +	
7	PC TxD				RS232 Transmit
8	PC RxD				RS232 Receive
9	AUX Data -			Transmit/ Receive -	

MMI to PC, MT5_PC Cable Configuration

Connect to Personal Computer (PC) RS232 Serial Port DB9 Female	Connect to MMI (HMI) RS232/485 [PLC] DB9 Female	Connect to Controller RS485 Port DB9 Male
1 Not used	1 RX- →	1 RX-
7 Not used	2 RX+ →	2 RX+
8 Not used	3 TX- →	3 TX-
4 Not used	4 TX+ →	4 TX+
5 GND →	5 GND →	5 GND
6 Not used	6 AUX Data +	6 AUX RS485+
2 TxD →	7 TxD	7 Not used
3 RxD →	8 RxD	8 Not used
9 Not used	9 AUX Data -	9 AUX RS485-

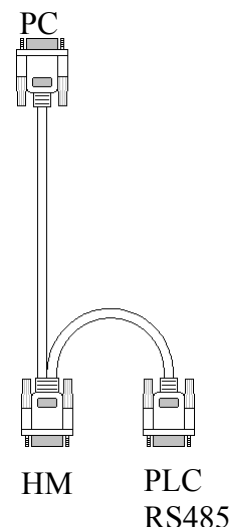

4.2 CONNECTION TO A CONTROLLER

Cable Requirements Different cables are required for various devices. See Controller Reference Section for cable details. The KEP part numbers have the SMIC prefix. Refer to a KEP catalog or data sheet for a complete listing of MMI compatible devices. These cables can be obtained from the same distributor where you purchased the MMI.

Error Messages Communications problems cause the display to show “PLC no response...” until communications can be established. During this time, the controller cannot be affected by the MMI. The COM light on the front of the MMI turns on with each communication and should appear as if always on or slightly flickering when communications are good.

Restrict cable length to avoid communications problems due to weak signals.

Recommended distances:

RS232: less than 50’ (15m)

RS485/422: less than 500’ (150m)

Ethernet: less than 328’ (100m)

Shielded cable must be used for long lengths or cables run in an electrically noisy environment.

Use twisted pair cables for all Ethernet connections.

Do not run cables next to AC power lines or near sources of electrical noise.

Be sure that the cable ends have been inserted all of the way into mating connectors and are secure.

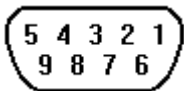

Pin Designations

Pin assignment of the 9 Pin, Female, D-SUB, **PLC [RS-232]** Port. This port is used for connecting the MMI to a controller or Master MMI unit. The Auxiliary (AUX) RS232 port is also accessed through this connector. Both PLC and AUX ports share the common ground.

Note: This port is not used for programming the MMI or for printing functions. Do not plug the **MT5_PC**'s PLC cable end into this port.

Pin #	Symbol	PLC[RS232]	AUX[RS232]
1	AUX TxD		Transmitted Data
2	PLC TxD	Transmitted Data	
3	PLC RxD	Received Data	
4	Not used		Received Data
5	GND	Signal Ground	Signal Ground
6	AUX RxD		
7	PLC CTS	Clear to send input	
8	PLC RTS	Ready to send output	
9	Not used		

Ethernet Connections

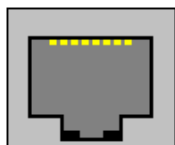

Units equipped with the Ethernet port can be connected to Ethernet devices using standard 10T CAT5 Ethernet cables. Routing may pass through Hubs and Servers as needed to connect to the PLC.

The Ethernet port can also be used for MMI Master/Slave communications using the same type of configurations.

Connect directly to PLC using 10T Crossover cable



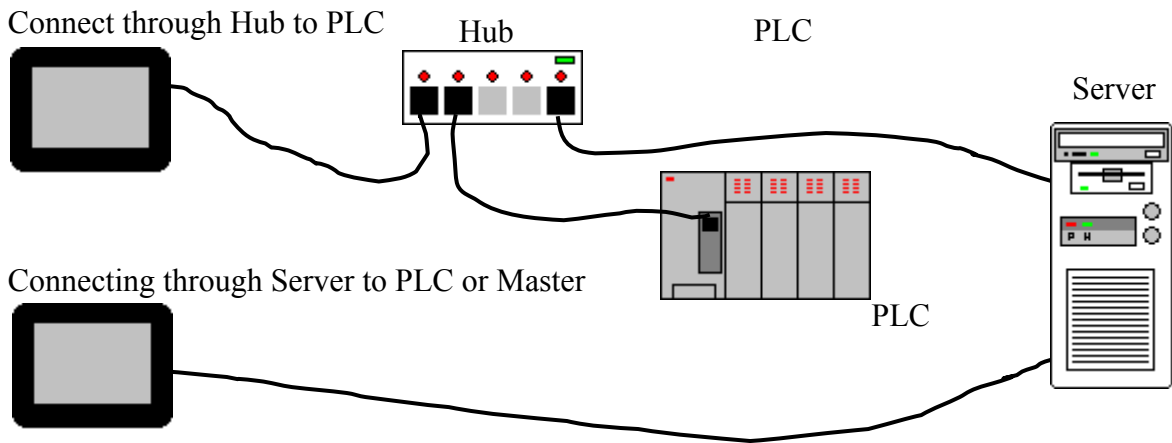

4.3 MMI TO MMI CONNECTIONS

The MMI supports a master - slave communications. One MMI is connected directly to the PLC and configured as the Master. All the other MMIs are connected in series to it and are configured as Slaves. In theory there is no limitation to the number of MMIs on a chain, however response time gradually decreases when more than three MMIs are linked together. The MMI's are configured with the EasyBuilder software to be the Master or a Slave.

Wiring between two MMIs

Case 1: Slave to Master, connect PLC[RS232] directly to PC[RS-232]/PLC[RS485] combination port.

Connect to SLAVE MMI PLC[RS-232] port Cable has D-SUB Male end	Connect to MASTER MMI PC[RS-232] port Cable has D-SUB Female end
2 TxD →	8 RxD
3 RxD →	7 TxD
5 GND →	5 GND
	Shield → Earth Ground
<p>SubD 9 Male Socket View from end</p> <p>SubD 9 Female Plug View from end</p> <p>Connect to Earth Ground</p>	

Case 2: Slave to Master, connect PLC[RS232] to PC side of split download cable (MT5_PC) with use of Male to Male Null Modem cable.

Connect to SLAVE MMI PLC[RS-232] port Cable has D-SUB Male end	Connect to MT5_PC to MASTER MMI PC[RS-232] port Cable has D-SUB Male end
2 TxD →	3 RxD
3 RxD →	2 TxD
5 GND →	5 GND
	Shield → Earth Ground
<p>SubD 9 Male Socket View from end</p> <p>SubD 9 Male Socket View from end</p> <p>Connect to Earth Ground</p>	

Case 3: Ethernet Connections: Units equipped with the Ethernet port can be connected via Ethernet to a Master and Slaves using standard 10T Ethernet cables. Slave to Master, connect the Ethernet ports with a standard (Category 5) Ethernet 10T crossover cable (RJ-45 to RJ45). Alternatively, use standard cables with routing passing through Hubs and Servers as needed.

Connecting a Master directly to a Slave using 10T Crossover cable

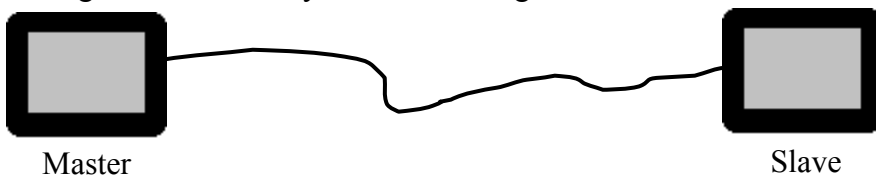

Connecting a Master through a Hub to Slaves

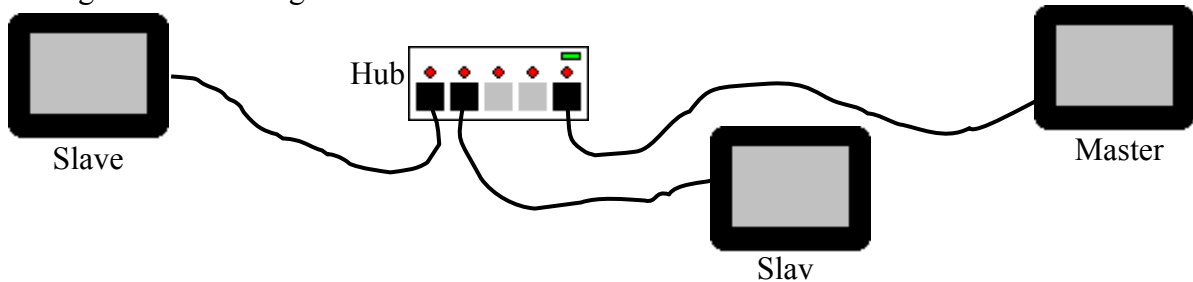

4.4 MMI TO PRINTER CONNECTION

The printer port on the back of the unit is a Parallel printer port and is compatible with most printers that accept parallel connectors. A standard parallel printer cable is used.

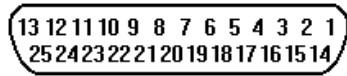

The printer port transmits data when a printable object is activated. Pin assignment of the 25 Pin, D-SUB, Parallel **Printer Port**.

Pin Designations

Pin #	Symbol	Function
1	STB	Output
2	DATA0	Output
3	DATA1	Output
4	DATA2	Output
5	DATA3	Output
6	DATA4	Output
7	DATA5	Output
8	DATA6	Output
9	DATA7	Output
11	BUSY	Input
15	ERROR	Input
16	INIT	Output
17-25	GND	Signal Ground

5.0 Dip Switch Settings

All dipswitches should normally be in the OFF (down) position. Dipswitches 1 and 2 are used to perform testing and recovery functions. Dip Switch 3 and 4 are not used and should be left in the off position.

	SW1	SW2	Mode
	OFF	OFF	Application mode (On line operations, use EasyManager or EasyBuilder to change modes)
	ON	OFF	Force to Touch Adjust mode (Used for touchscreen calibration)
	OFF	ON	Force to RDS mode (Remote Debug and Simulation, used to recover from invalid states due to corrupt downloads. Refer to section on troubleshooting.)
	ON	ON	Force to Touch Screen Test mode (Used to check accuracy of Touch Screen)

Note: It is normally not necessary to change dipswitches to put the MMI into programming (RDS) mode.

6.0 MMI Indicator Lights

PWR – Indicates if power has been applied to the unit. If this indicator fails to light, check power, check polarity of wiring and check fusing. If all conditions are correct, contact the factory for help.

CPU – Indicates that the CPU is operating properly. If this indicator fails to light, please contact factory.

COM – Lights when a serial transmission is sent or received. This indicator appears to flicker when trying to establish communications.

7.0 Other Hardware Considerations

7.1 TOUCHSCREEN CALIBRATION

Normally the touchscreen is calibrated at the factory for proper functionality. If the touchscreen cannot be calibrated, please contact the factory for assistance.

Run the **EasyManager** Utility to get to the Touch screen calibration (Touch Adjust) mode.

Click **Jump to Touch Adjust** to put the unit in this mode. This is used to calibrate the touch screen.

On the screen of the MMI unit:

1. Touch the crosshairs as displayed in sequence on the screen.
2. Touch anywhere outside to the rectangles to move the crosshairs to that location.
3. Touch inside the left rectangle to repeat the calibration process.
4. Touch inside the right rectangle to accept and end the calibration procedure.
5. Touch the screen again to jump to application mode.

7.2 BATTERY REPLACEMENT

The MMI-850 takes one coin type of CR2032 lithium battery to backup the recipe data and keep the RTC running.

Battery specification: CR2032 3V lithium battery.

Steps for battery replacement:

1. Use EasyManager to backup the retentive memory data.
2. Turn off the screen and open its rear cover.
3. Use a small screwdriver to remove the battery from the socket.
4. Insert a new battery into the socket.
5. Put on the rear cover.
6. Reset the RTC time and download the retentive memory data.

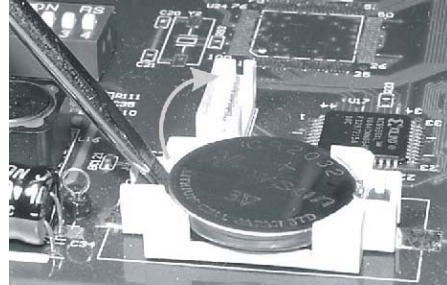

8.0 Trouble Shooting

8.1 POWER PROBLEMS

Problems on power up: Unit does not light or unit lights but does not display any windows.

1. Check wiring for proper polarity.
2. Check power Supply for proper Voltage and Current capacity.
3. Check fuse.

Problems during operation: Faulty unit operation may be due to problems with power quality. The MMI has been designed to work in environments where electrical noise is present. However, extreme electrical noise still causes problems. Make sure that the system is properly earth grounded.

8.2 COMMUNICATIONS PROBLEMS

Sometimes communications fail. When communications fail, the unit automatically tries to establish the communications link again. During the time the unit is establishing communications, the touchscreen of the unit does not respond. Function key operations are interrupted. The implication is that the unit should not be used for Emergency Stop applications. A loss of communications can happen at any time. Using the function keys on the unit for critical operations can lead to a potential disaster. It is good programming practice to allow for safe operation in case of interface failure.

There are various reasons why this happens;

Improper programming: If the MMI window is programmed to access data from an invalid register or bit address for the PLC, the unit receives an error message from the PLC. The unit interprets this as a loss in communications. Be sure that all data points being displayed are valid for the PLC that is connected.

Loose or incorrect cables: Make sure that all cables are secured and configured properly for the PLC.

Time outs: Make sure that the PLC is responding to requests from the MMI in a timely manner.

Power loss: Make sure the PLC has power and is running properly.

Electrical noise: Faulty unit operation may be due to problems with power quality. The MMI has been designed to work in environments where electrical noise is present. However, extreme electrical noise still causes problems. Make sure that the system is properly earth grounded.

The use of proper grounding techniques insures reliable communications. Make sure the controller and the MMI are connected to good earth ground sites. This allows EMI (Electro-Magnetic Interference, commonly called electrical noise) to be channeled to ground where it can no longer disrupt electrical operations. Be sure to route communications cables in separate bundles and locations from AC power and control wiring. Do not run communications cables near solenoid and relay coils or AC and DC drive controllers. Care should also be taken to locate the MMI itself away from sources of EMI.

8.3 REPAIRS AND RETURNS

An MMI is designed to provide years of trouble free service. An MMI under goes a full functional test before shipment.

The MMI warranty is for one year under normal use. The MMI does not require any “Routine Maintenance” by the user. If a problem should occur, and all troubleshooting procedures have been exhausted, contact your local representative or distributor.



Use our toll free number to contact KEP if persistent problems are encountered.
Telephone: 1-800-631-2165.

If the product must be returned for any reason, be sure to call KEP and get a Return Goods Authorization (RGA) number first.

Units should be returned in their original packaging container, otherwise, any suitable rigid container can be used as a substitute. Use appropriate packing material. Damage due to shipment is not covered by the warranty. Be sure to include a description of the problem and contact details for our repair department. All returns are evaluated for proper operation. During evaluation, customer projects are not retained in the units. If you need your project retained, please indicate this in the documentation included with the unit. Products passing normal QC tests are returned to the customer and an evaluation charge is incurred. If the problem is verified and the unit is in warranty, KEP will repair or replace the unit.

9.0 Specifications

9.1 GENERAL SPECIFICATIONS

Item	Specification
Input power	21-25 VDC, 500 mA @ 24VDC
CE	Complies with EN50081-2 and EN50082-2 standards
EMI	Complies with FCC Class A (Ferrite core required if using unshielded power supply wires)
Isolation resistance	Exceeds 50 MΩ at 500VDC
Vibration endurance	10 to 25 Hz (X,Y,Z direction 2G 30 minutes)
Protection structure	NEMA 4 / IP65 front panel (when mounted with gasket seal)
Operating Temperature	32 to 113 °F (0 to 45 °C)
Operation humidity	10 to 90% RH Non Condensing
Enclosure	Plastic: Polybutylene Terephthalate (PBT) and Polycarbonate(PC)

9.2 HARDWARE SPECIFICATION

Item	Specification
LCD Display	7.7” STN, 256 color Contrast Ratio 30:1
Display area (mm)	162(W) x 123(H)
Back light	CCFLx2 (MTBF 25,000 hr) Brightness cd/m2 150
Resolution pixels	640(W) x 480(H) Pixel size 0.33(W) x 0.33 (H) mm
Touch panel	4 wire resistive type
Touch granularity	2mm grid
Touch Feedback	Beeper and or Graphic Indicator
Surface hardness	4H
Processor	32 bit RISC CPU 200 MHz
Flash ROM Memory	2 MB Standard, 4MB with Ethernet option
System Memory	4MB DRAM
Battery Held Memory	128kB with Y2K compliant Real Time Clock/Calendar
Compact Flash Slot	Used for Project transfers only
Serial ports	1 RS-232 (Controller / Auxiliary port) 1 RS-485 (Controller / Auxiliary port) 1 RS-232 (PC port)
Parallel port	Standard parallel printer port
Ethernet Port	RJ-45 8 wire (10 BaseT) TCP/IP
System diagnostic	Watch dog timer, power failure detection
Dimensions	Bezel: H x W x D inches 6.93 x 9.09 x 2.16 (H x W x D) mm (176 x 231 x 55) Cutout: H x W inches 6.57 x 8.75 (H x W) mm (167 x 222)
Weight	Approx. 1.2 kg

9.3 FUNCTIONAL SPECIFICATION

Screen editor	EasyBuilder (to be run under Windows 98 / NT / 2000 / ME / XP*)
No. of window	1 ~ 1999, limited by memory
No. of object	Up to 500 per window, limited by memory
Text strings	limited only by memory
Bitmap graphics	256 KB per graphic, limited by memory
Support PLC	Most popular PLC's
Support Printer	EPSON ESC/P2, HP PCL/(Simple page mode) or compatible
Macro scripts	Up to 256 Macro scripts per project, limited by memory

Computer requirements include at least a Pentium 90Mhz PC, 16MB RAM, 10MB available hard disk space, minimum 800x600 resolution VGA, and one available RS-232 serial port.

9.4 DIMENSIONAL SPECIFICATION

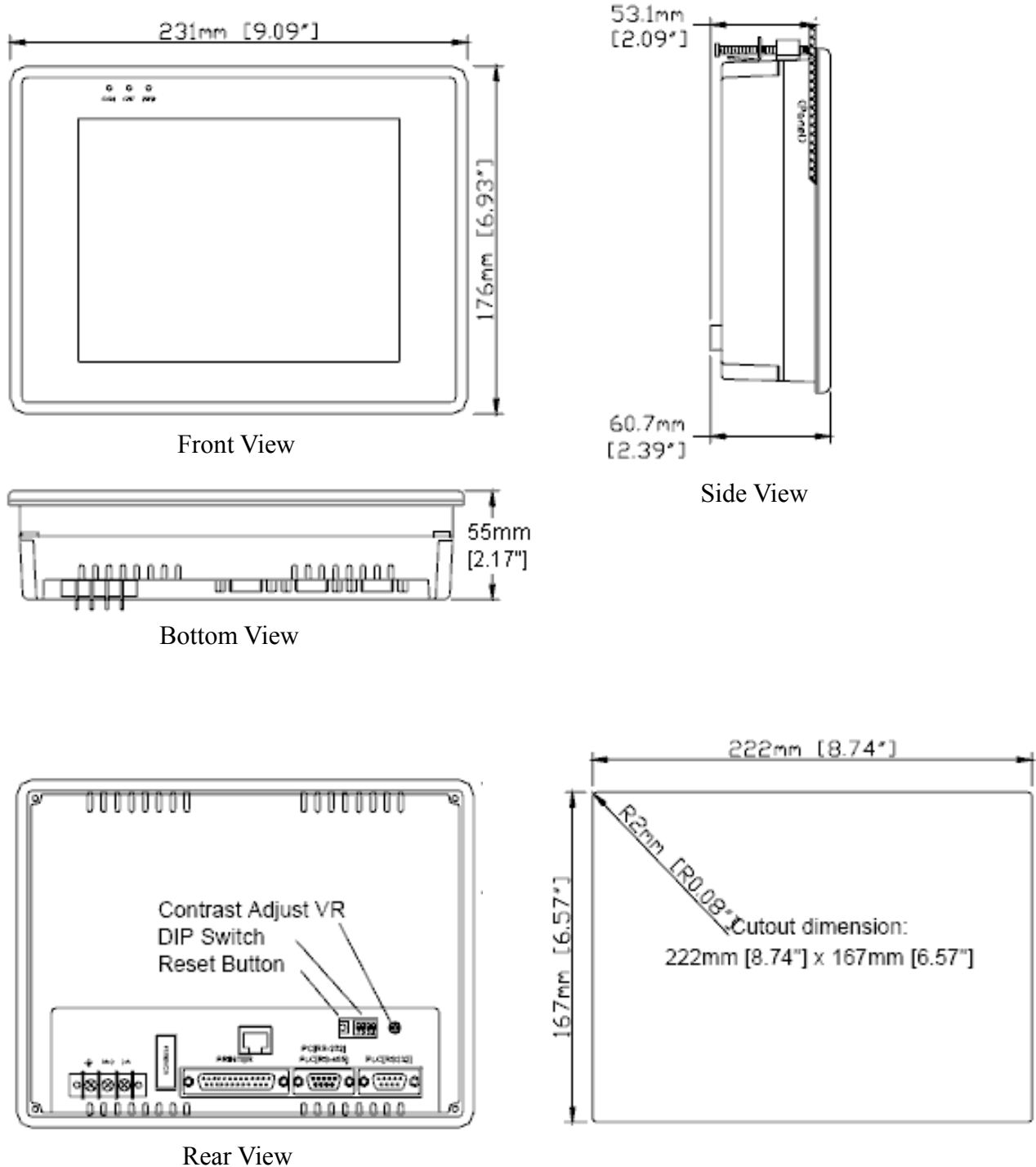

Kessler Ellis Products
 10 Industrial Way East
 Eatontown, NJ 07724
 Phone: 732-935-1320 Fax: 732-935-9344
 www.kep.com